



Multi-door video entry system

USER MANUAL

For 4-wire villa system

CE FC RoHS 

4-WIRE VILLA SYSTEM CONFIGURATION DIAGRAM

FOUR MONITORS WITH TWO ENTRANCES

Indoor monitor built-in power supply

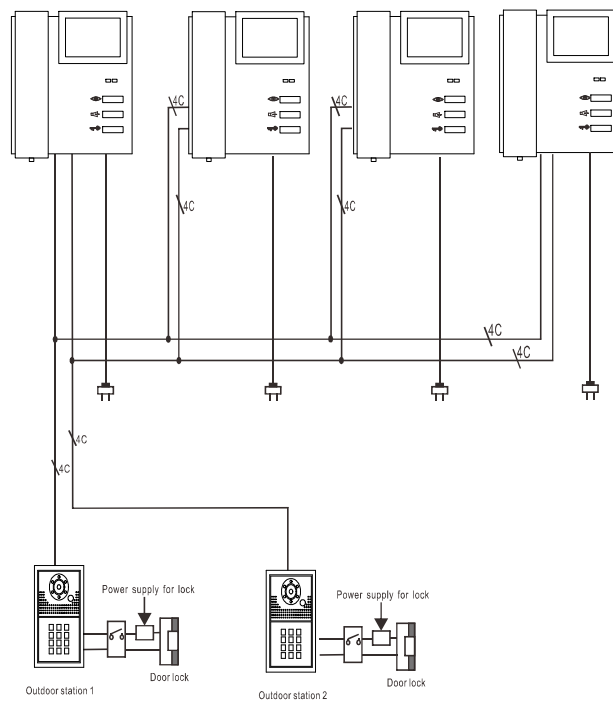

4-WIRE VILLA SYSTEM CONFIGURATION DIAGRAM

FOUR MONITORS WITH TWO ENTRANCES Indoor Monitor with external power supply

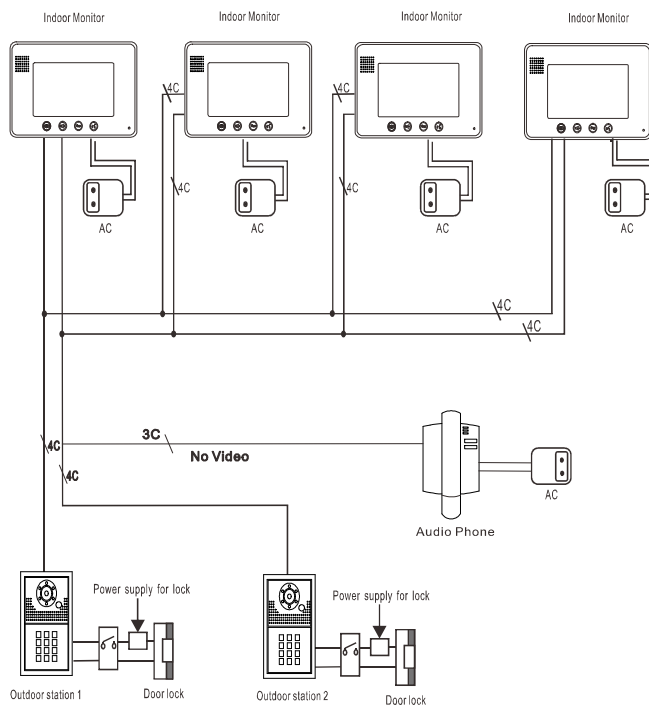

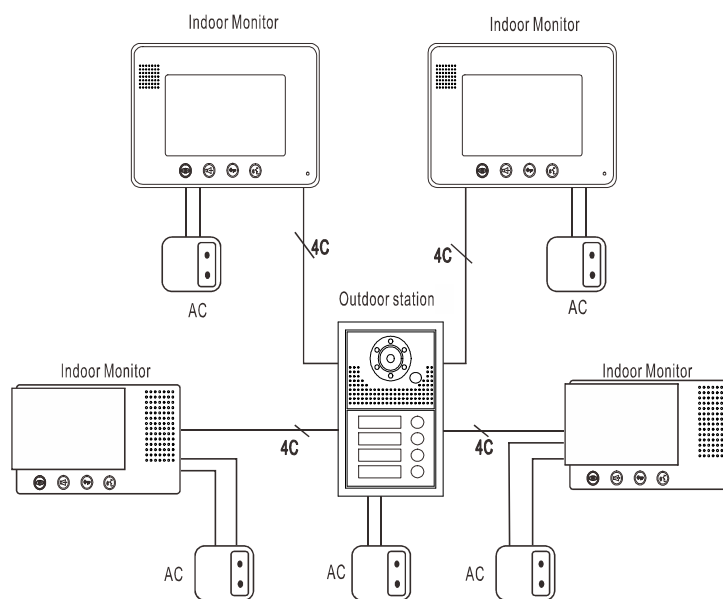

4-WIRE VILLA SYSTEM CONFIGURATION DIAGRAM

MULTI-BUTTON OUTDOOR WITH MONITORS











Note:

1. Keep pressing  button on the Indoor Monitor for 3 seconds, when you hear a long sound “di...” then you can connect the Indoor Monitor to the multi-button Outdoor Station.
2. Before connect these Indoor Monitors(from above connection) to the Outdoor Station of the normal Villa kit (non multi-button Outdoor Station), please keep pressing  button till it rings “ding dong”.

Specification

Power	DC 15V 1.5A
Illumination (minimum)	0.1 LUX
Communication duration	120s
Communication method	Duplex communication
Working temperature	-25°C ~ +65°C
IP rating	55

No.	Icon	Description	No.	Icon	Description
①		Monitoring	⑤		Brightness
②		Unlocking	⑥		Chroma/contrast
③		Talking	⑦		Transferring
④		Talking volume	⑧		Ring volume

CAUTION:

1. When connect with more than one Indoor Monitor, please connect with the J2 of the farthest Indoor Monitor, and disconnect the J2 of the rest Indoor Monitors.
2. When connect with more than one Indoor Monitor, please connect with the J1 of the closest Indoor Monitor, and disconnect the J1 of the rest Indoor Monitors.

SYSTEM DIAGRAM

► Wiring connection

1. Blue -Audio
2. Black -GND
3. Red -V+
4. Yellow -Video

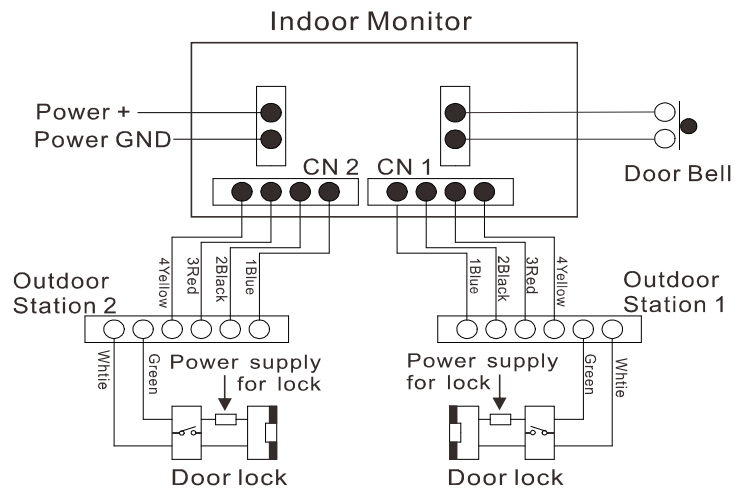

NOTE:

- Maximum 4 Indoor Monitors and 2 Outdoor Stations or connect one Outdoor Station and one extra camera.
- Parallel connection.
- Each Indoor Monitor needs power supply.
- Intercom between Indoor Monitors.
- Each Indoor Monitor can monitor two Outdoor Stations or camera.
- Cables of the system: Wire $\geq 0.5\text{mm}^2$, from Outdoor Station to the farthest Indoor Monitor distance $\leq 70\text{m}$.

OPERATION

►Visitor calls

The visitor press the call button on outdoor station-1





a chime sounds

The visitor press the call button on outdoor station-2



a chime sounds

* Press  at anytime, the Indoor Monitor will show the image from the door camera automatically. Press  to have communication with the visitor.

The visitor image appears on the monitor



Dialogue begins

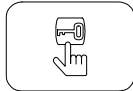

Dialogue duration is up to 120 seconds at a time

Check

Open the door

After pressing the unlock button, the Indoor Monitor still displays the image from the door camera.

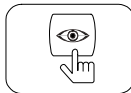

Press the TALKING button or hang-up the handset



End the call

► MONITOR

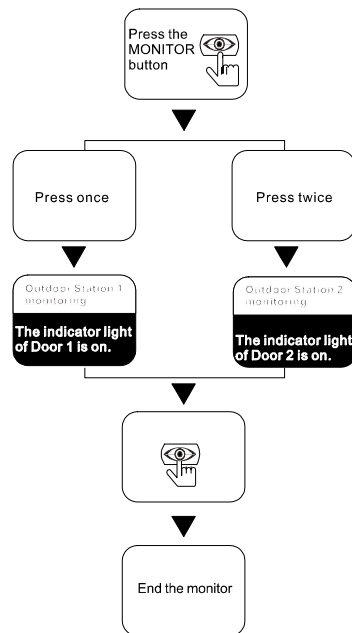



*This function is to see the image from the door camera.

■ Transfer the Outdoor Station call

During the conversation between the Outdoor Station and one of the Indoor Monitors, press  on this Indoor Monitor.



Other Indoor Monitor (or Audio Phone) ring, the first one press  (or pick up the handset) to communicate with the Outdoor Station, press  again (or hang up the handset) to end the talking or press  (or ) to transfer to other Indoor Monitors (or Audio Phone)

■ Call from Indoor Monitor (or Audio Phone)

Each Indoor Monitor can press  to call other Indoor Monitors (or Audio Phone press  to call).

Picture Memory Function

■ Visitor calling

Taking pictures automatically and saved

Under standby status checking pictures by pressing **[F5]**.
Deleting one picture by pressing **[Left]** and confirm. Press **[F5]** to exit.

Deleting all photos by pressing **[F5]** for 3 seconds, press **[F5]** choose "Delete All"

Press **[F5]** select "Photo", and press **[F5]** delete all photos.
Press **[Left]** to exit.

DVR Function

Under the calling or monitoring status, recording video by pressing **[F5]** for 3 seconds and press **[F5]** to select "Video", then press **[F5]** to record.

Playing the saved Videos by selecting "Play", then press **[F5]** to play. Press **[Left]** to exit.

Take out SD card from indoor monitor

Play or Delete the videos by PC

Deleting all photos or videos by pressing **[F5]** for 3 seconds, press **[F5]** choose "Delete All"

Press **[F5]** select "Video", and press **[F5]**, it will display: **Format?**
Yes
NO...
then press **[F5]** select "yes" and then press **[F5]** to delete all saved videos. Press **[Left]** to exit.

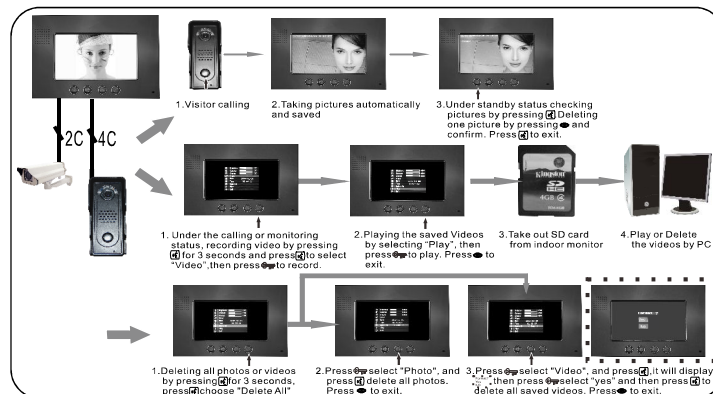

Features:

1. Maximum 2 Outdoor Stations or cameras.
2. Maximum 4 Indoor Monitors.
3. Intercoms between Indoor Monitors.
4. 70m distance with 0.5mm*4 wires.
5. Picture memory & video recording.
6. Video saved in SD card.
7. Any status calling is priority.
8. Any operation status it will exit standby status after 60 seconds.

Specifications of 591 series code access

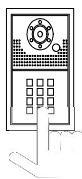

⚠ ATTENTION

1. The original factory default password is 1234.
2. In the programming mode, set 40 groups of 4-digit passwords to unlock door.

Modify the programming password

1. Switch off the power, press * button and hold, switch on the power. After a lasting sound Di... is heard, release * button.
2. The lasting sound stops, then enter 4 digits (can be set as 2-6 digits) new programming password (the length same as original code), another long Di sound is heard, it indicates modifying success.
3. Press * to exit the programming mode.

Enter to the programming mode

1. Press *, a Di sound is heard, enter the 4 digits (can be set as 2-6 digits) programming password, a long Di sound can be heard, it indicates entered the programming mode successfully.
2. Within 30 seconds without any operations it will exit the programming mode, or press * to exit.

Set unlock time

- Factory default setting is 1 second.
1. Enter to the programming mode first.
 2. Press 00, a long Di sound is heard, enter 2 digits (from 01-99) as the unlock time, another long Di sound can be heard, it indicates setting success.
 3. Press * to exit the programming mode.

Add user passwords

1. Enter to the programming mode first.
2. Enter 2 digits(from 01-40), a long Di sound is heard, press 4 digits (can be 2-6 digits) password, another long Di sound can be heard, it indicates adding success.
3. Press * to exit the programming mode.

Delete user passwords

1. Enter to the programming mode first.
2. Enter 2 digits(from 01-40), a long Di sound is heard, press # to confirm, another long Di sound can be heard, it indicates deleting success.
3. Press * to exit the programming mode.

Delete user passwords directly

1. Enter to the programming mode first.
2. Press#, when DiDi sound is heard, enter that 4 digits(can be set as 2-6 digits) password you want to delete, a long Di sound can be heard, it indicates deleting success.
3. Press * to exit the programming mode.

Setting the length of password

1. Enter to the programming mode first.
2. Press 99, a long Di sound is heard, then enter 2-6 digits, another long Di sound can be heard, it indicates setting success.
3. Press * to exit the programming mode.

Delete all settings

1. Enter to the programming mode first.
2. Press #, when a DiDi sound is heard, press # again, a long Di sound can be heard, then press # for 7 times, after 3 seconds, another long Di sound will be heard, it indicates deleting success(The unlock time changes to 1 second and the programming password does not change).
3. Press * to exit the programming mode.

Restore factory mode

Switch off the power, press # and hold, switch on the power. After a long Di sound is heard, then release #, restoring success. (the system restore factory programming password 1234 and clear out all the set passwords)